

Projekt domu Garaż G1

autor: Iwona Flak
cena projektu: 735 zł

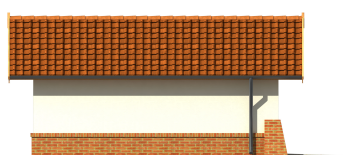

Powierzchnia użytkowa	29,40 m²
Powierzchnia zabudowy	38,20 m ²
Kubatura netto	95,00 m ³
Powierzchnia dachu skośnego	70,50 m ²
Kąt nachylenia dachu	30°
Wysokość budynku	4,50 m
Min. wymiary działki dł.	14,68 m
Min. wymiary działki szer.	11,98 m
Liczba pokoi	0
Liczba łazienek	0
Garaż	1

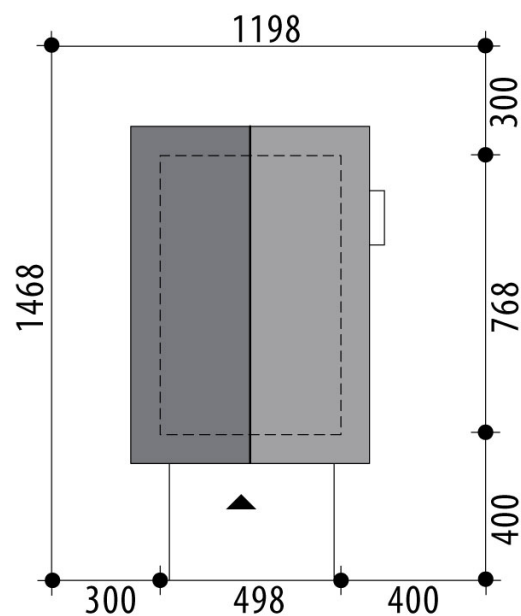

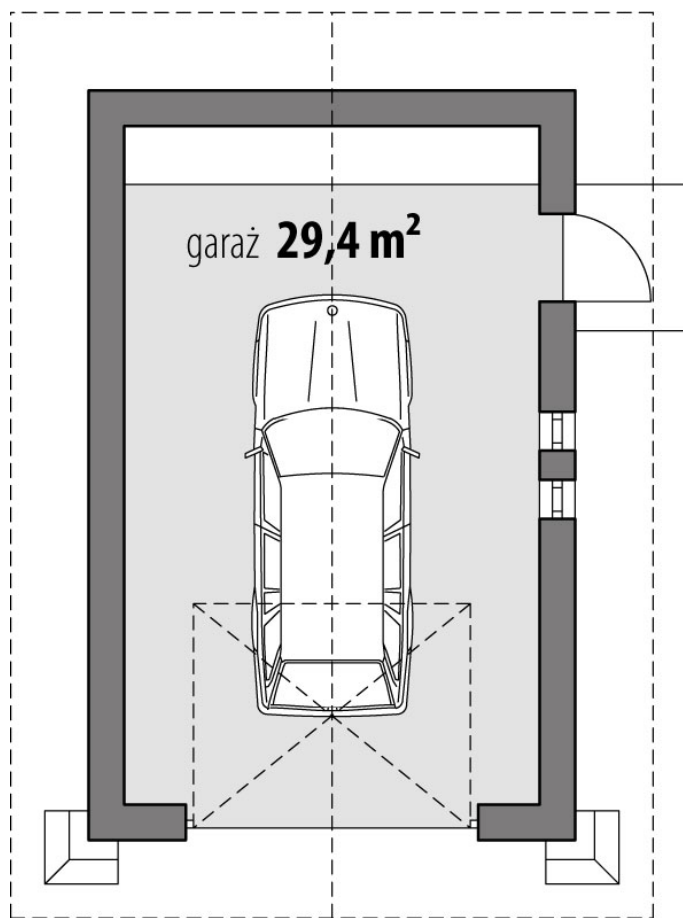

RZUT PARTER

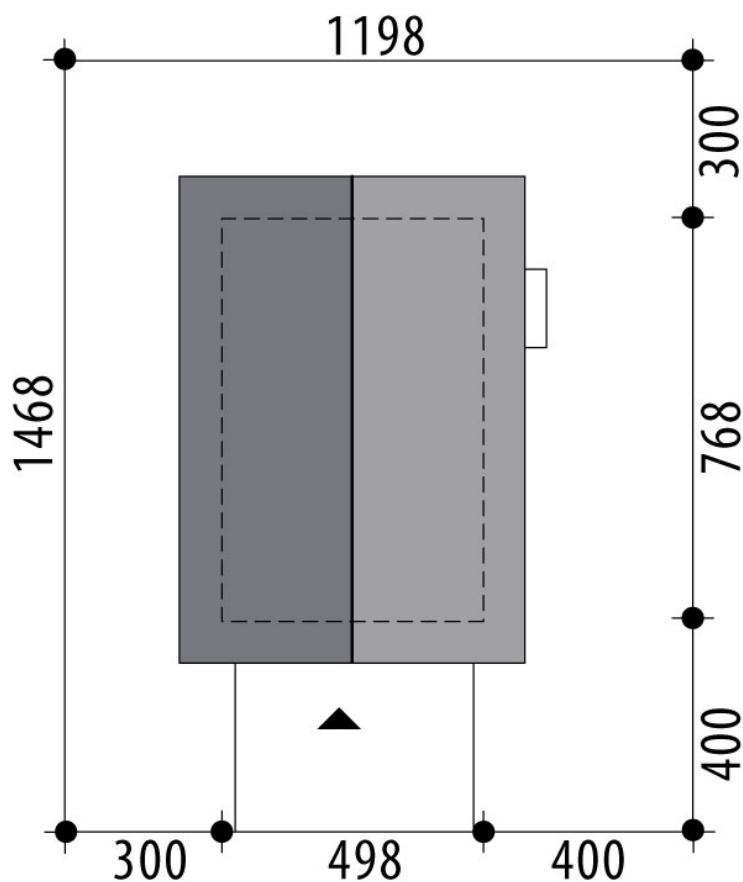

RZUT DZIAŁKI

